

SCL

Coil Lag™

The Steel Dog® Coil-Lag™ is designed to provide a temporary means of attaching formwork to wood structures. Typical application: one-sided forming against soldier piles with wood lagging.

FEATURES:

- Standard hex head lag bolt for socket wrench installation.
- Swivel loop coil tie end to accommodate misalignment between lag bolt placement and formwork tie location.
- Accepts standard 1/2" coil rod or 1/2"-13 NC rod (SCL-4NC)
- Less expensive than toggle ties, and doesn't require clear space behind timber (compacted soil not a problem).
- Eliminates expensive external bracing or welding.
- Long version (SCL-4-10) can be used with foam for waterproofing installation

MATERIAL: Bolt is ASTM A307. Swivel loop wire is AISI C1038.

FINISH: None. Zinc coatings available; consult factory.

MAXIMUM SAFE WORKING LOAD: 3000 Lbs. (2-to-1 safety factor). **Actual Safe Working Load will depend on pull-out strength of lag in wood and off-axis loading angle.** See tables at right.

INSTALLATION:

- Install only into pre-drilled hole (9/16" diameter MAX)
- Use wax or other suitable solid lubricant on lag bolt threads (especially in hardwood species.)
- Screw bolt into wood using wrench on bolt hex head only. **Do not use swivel loop to turn bolt.** If excessive resistance is met, unscrew bolt and re-lubricate or change bolt location. If using powered socket driver (such as right angle drill or impact wrench), apply 400 ft-lb max torque. Bolt should be screwed into wood until swivel loop is just in contact with wood surface (SCL-4) or until threaded through full thickness of timber (SCL-4-10).
- If wood splits when installing lag bolt, the bolt will not hold the rated load. Move bolt location at least 1-1/2" across grain.
- Swivel loop may be loaded up to 30° off-axis when rotated in "A" direction, and up to 90° off-axis when rotated in the "B" direction (see diagram at right).
- Generally, the **withdrawal resistance of the bolt from the wood and the off-axis load angle will determine the allowable tie load** on the swivel loop coil. When loading off-axis, (see tables at right), consideration must be given to translation forces or torque on timber element due to lateral bolt loads.

• Not intended for installation into end grain.

• Not intended for installation into end grain.

WOOD LAGGING LOADS:

Because wood lagging timber widths vary, and are unlikely to match the formwork tie spacing, the lag bolt locations will vary on the pattern of wood lagging. Ideally, there should be a row of Coil-Lags attached to every lagging timber so that the liquid concrete pressure is spread evenly. If some timbers are skipped, then timbers without Coil-Lags will see a net bending moment in a direction opposite to the soil pressure loading, and adjacent timbers with Coil-Lags will see a net bending moment in the same direction as the soil pressure load. THIS ADDITIONAL LOAD ON THE TIMBERS MUST BE FACTORED INTO THE DESIGN OF THE SOLDIER PILING, FORMWORK, AND ALLOWABLE POUR PRESSURE.

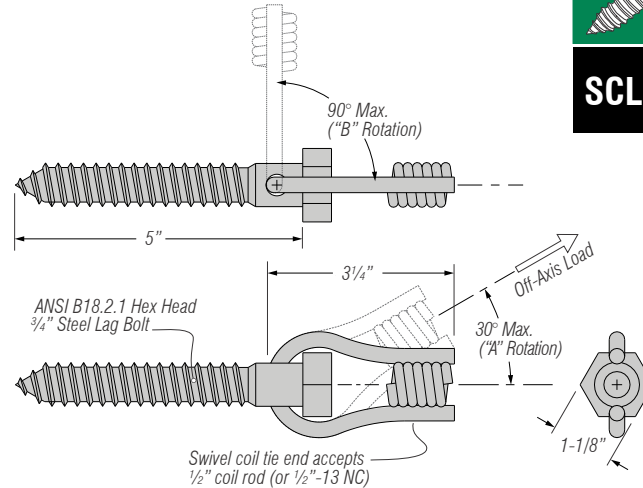

| ORDER INFO | | | | | |
|--|---------------------|--------------|----------------|------------------|----------------|
| Installed with loop in contact with wood: | | | | | |
| | Product Code | SCL-4 | SCL-4NC | SCL-4-10† | SCL-D15 |
| Safe Working Load* | 3000 lbs | | 3000 lbs | 3000 lbs | 3000 lbs |
| Lag Screw Size | 3/4" | | 3/4" | 3/4" | 3/4" |
| Lag Screw Length | 5" | | 10" | 5" | 5" |
| Coil Thread | 1/2" | 1/2"-13NC | 1/2" | 15mm | 1/2" |
| Box Quantity | 50 pcs | | 25 pcs | 50 pcs | 50 pcs |
| Box Weight | 37 lbs | | 34 lbs | 52 lbs | 50 lbs |
| *For Coil-Lag itself at 2-to-1 Safety Factor. ACTUAL ALLOWABLE LOAD WILL DEPEND ON INSTALLATION AND TYPE OF WOOD. SEE TABLES BELOW. † For use with up to 5" of foam for waterproofing installations | | | | | |

| Wood Species | Specific Gravity ³ | Axial Lag Withdrawal Load In Different Thickness Wood ^{1,2} | | | | | | Off-Axis Load Angle | Off-Axis Load Factor ^{4,5,6} | |
|--------------------|-------------------------------|--|------|--------|------|--------|------|---------------------|---------------------------------------|--------------|
| | | 1 1/2" | 2" | 2 1/2" | 3" | 3 1/2" | 4" | | With Grain | Across Grain |
| Oak, Red | 0.62 | 1590 | 2120 | 2660 | 3190 | 3720 | 4250 | 10° | 1.0 | 1.0 |
| Western Larch | 0.53 | 1260 | 1680 | 2100 | 2520 | 2940 | 3360 | 30° | 1.0 | 0.7 |
| Douglas Fir | 0.50 | 1150 | 1540 | 1920 | 2310 | 2690 | 3080 | 45° | 0.9 | 0.5 |
| Western Hemlock | 0.48 | 1090 | 1450 | 1810 | 2170 | 2530 | 2890 | 60° | 0.7 | 0.4 |
| South. Yellow Pine | 0.48 | 1090 | 1450 | 1810 | 2170 | 2530 | 2890 | 90° | 0.5 | 0.3 |
| Eastern White Pine | 0.37 | 730 | 980 | 1220 | 1470 | 1710 | 1960 | | | |

1. Load in lbs at approximate 3-to-1 safety factor. Figures based on $p = 8,100G^{2/3}D^{3/4}L$, where G is specific gravity, D is lag shank diameter, and L is penetration of threaded portion in wood (from Forest Products Laboratory Wood Handbook, 1999). **Load not to exceed 3000 lbs** in any case (shaded areas represent pull-out values which exceed max. SWL of the Coil-Lag™).
2. All load ratings are for bolt installation into side grain in sound wood, minimum 1/2" from edge and 4" from end of timber.
3. Specific gravity (density) figures are typical for kiln-dried samples of the listed species. **Load ratings based on S.G. figures shown; actual S.G. values for wood vary widely.** Unless actual S.G. is known, use next lower figure for load calculations, or perform pull tests on samples of wood to be used.
4. **SCL-4/SCL-4NC ONLY.** SCL-4-10 **NOT** rated for off-axis loading.
5. Multiply off-axis load factor times axial lag withdrawal load for allowable off-axis load. Example: 60° off-axis, with-the-grain load into 3" Douglas Fir would be $0.7 \cdot 2310 = 1617$ lbs max. Remember: this is the load applied to the swivel loop coil, NOT the axial load on the lag.
6. Off-axis load ratings apply only to bolts that are threaded into timber until swivel loop is in contact with wood surface.

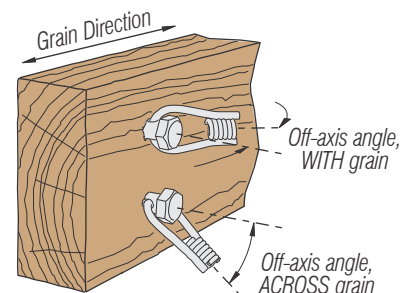

One-Sided Wall Application Against Wood Lagging

This example shows how Steel Dog® Coil-Lags™ are used to secure Steel-Ply® forms to wood lagging for a one-sided pour. (The same concept applies to 1-1/8" forms, aluminum forms, or the other forming systems that Transition Ties™ connect to.)

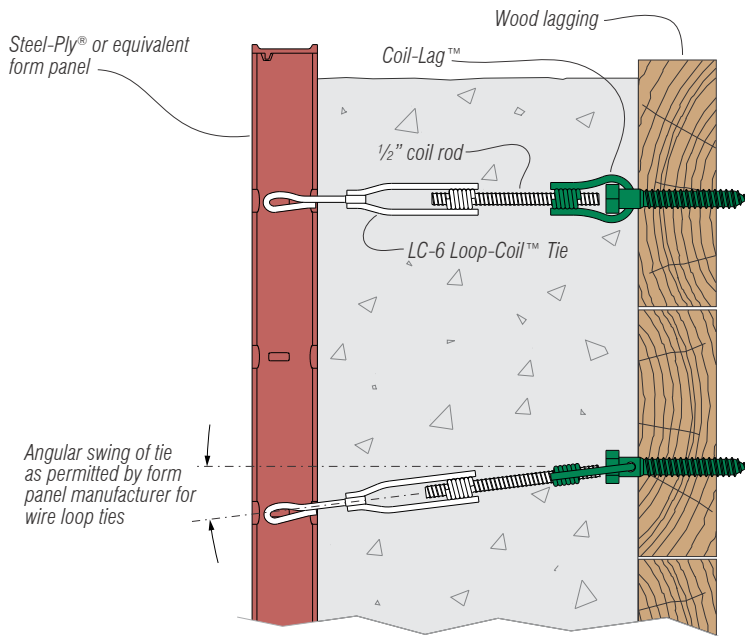

Installation

- Drill 9/16" (MAX) hole. (Min. 7/16" in softwood)
- Stay min. 1-1/2" from edge of board
- Avoid knots, splits, or areas of unsound wood

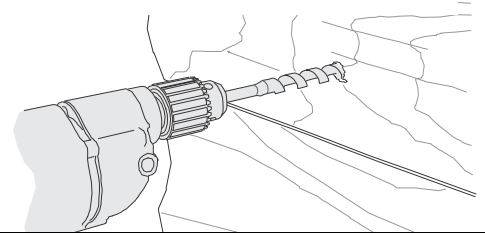

- Lubricate lag bolt threads with wax, soap, or other suitable solid lubricant

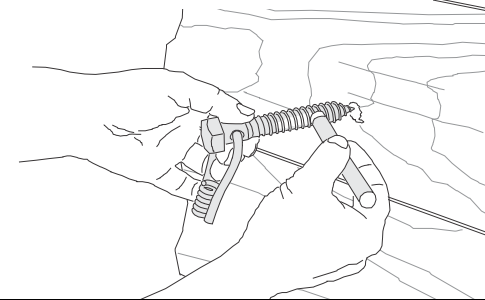

- Screw into wood using impact wrench or socket driver on bolt hex head (400 ft-lb torque MAX). If excessive resistance is met, unscrew bolt and re-lubricate

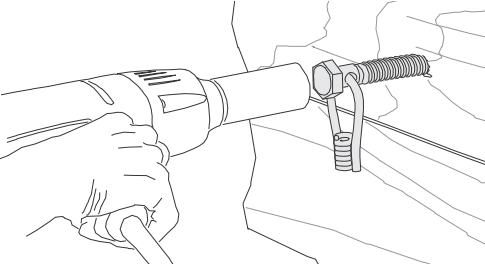

- Thread desired length of 1/2" coil rod into swivel loop coil
MAKE SURE THAT THREADED ROD EXTENDS AT LEAST 1/2" PAST COIL

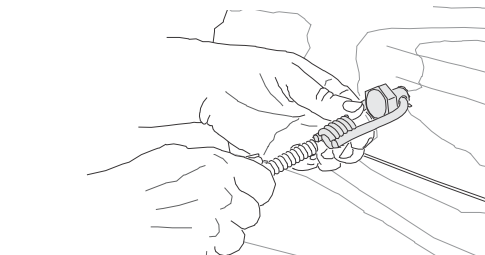

Complete One-Sided Forming Solutions

Whatever You're Up Against

The Steel Dog® Coil Lag™ is only one of a system of off-the-shelf, interchangeable forming components using industry-standard 1/2" coil rod as the threaded element.

